

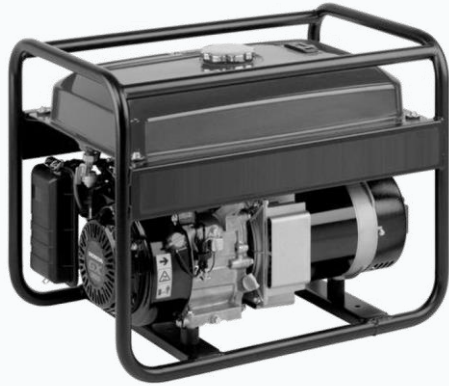

THE FUTURE OF ENERGY GENERATION

Drawbacks of currently used fossil fuel based technology



NOISY



HEAVY



HAZARDOUS



FOUL SMELLING

Our solution

HYDROGEN FUEL CELL
based smart electric
UP® GENERATORS



How our products work?

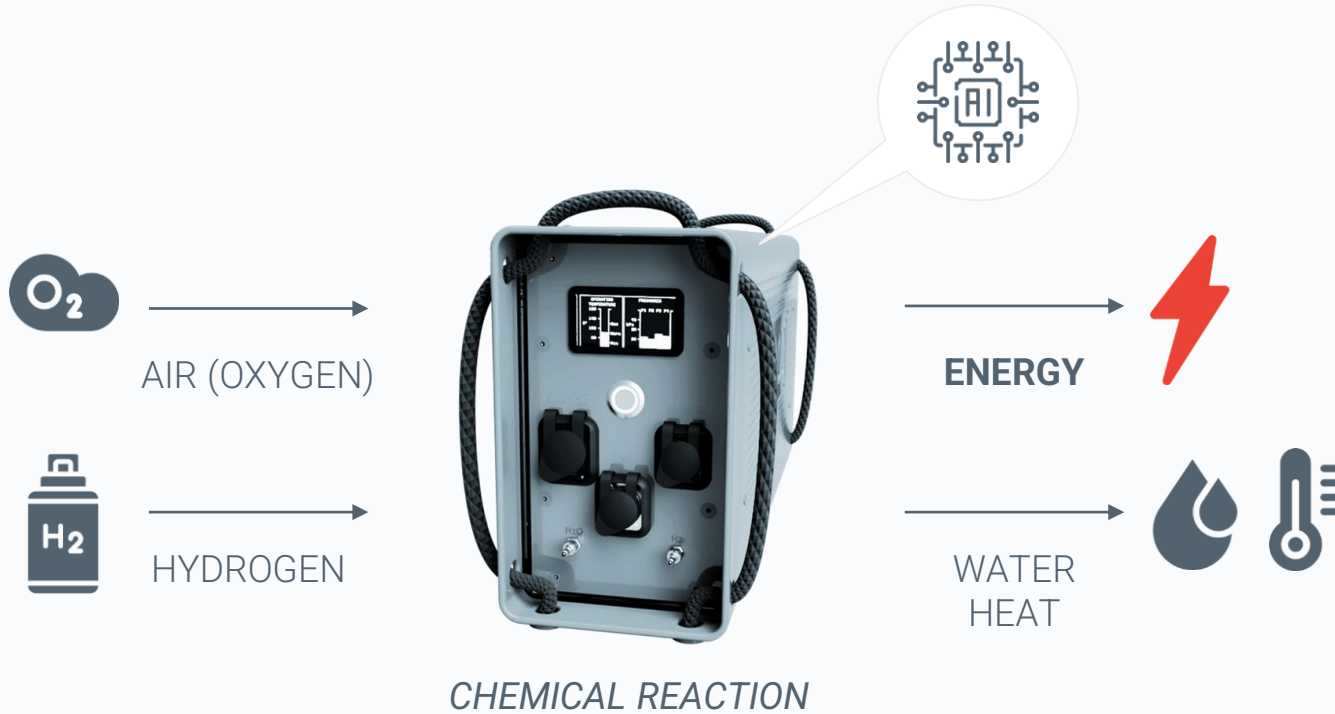

Product USP



LIGHTWEIGHT



NOISE-FREE



EASY TO USE



BATTERY COMPATIBLE



CERTIFIED-PATENTED



LOW
MAINTENANCE

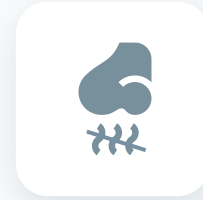

ODORLESS



UNIQUE AI

How are our products good for this planet?



ZERO CO2 EMISSION



PURIFIES AIR



95% RECYCLABLE

Our Target Market Segments



TELECOMMUNICATION



WIND TURBINES



ONGOING & 2022 PARTNERSHIP



ONGOING & 2022 PARTNERSHIP

B2B Market Segments through distributors



HOSPITALS



DISASTER RELIEF



EMERGENCY LIGHTING



CONSTRUCTION

B2BC Market Segments through distributors



OFF-GRID HOMES



LEISURE MOBILITY



MARITIME

Upcoming product portfolio

UP 6K



UP 1kW Fuel cell stack

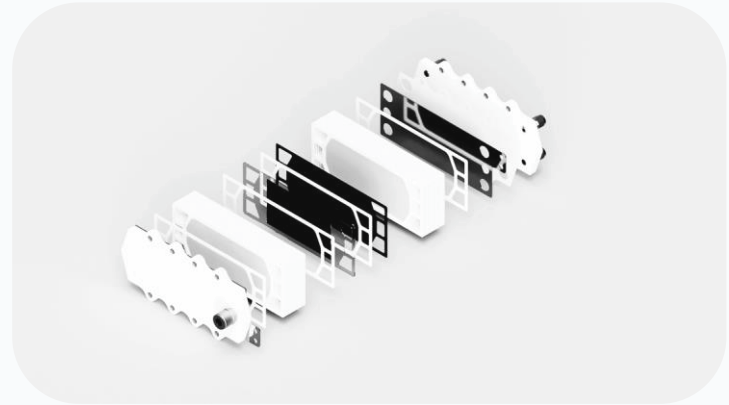

ChargeUP

Charge UP is one-of-a-kind **AI smart grid system** that includes a 400W hydrogen fuel cell generator (UP400), a solar panel, a Lithium-ion battery and a 5-inch display.

Targeted markets

Maritime & off-grid system

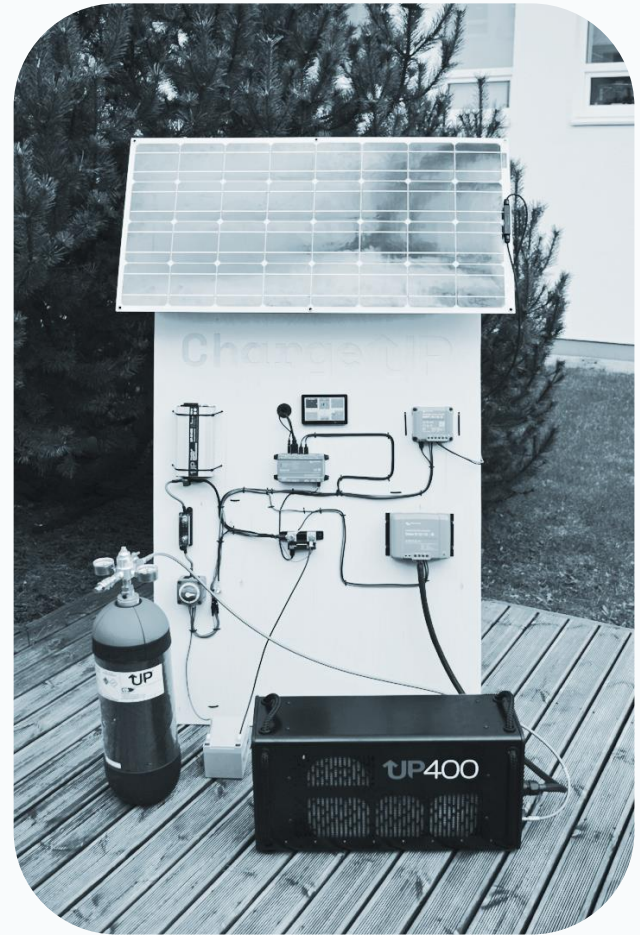

PowerAPP SaaS platform for hydrogen distribution

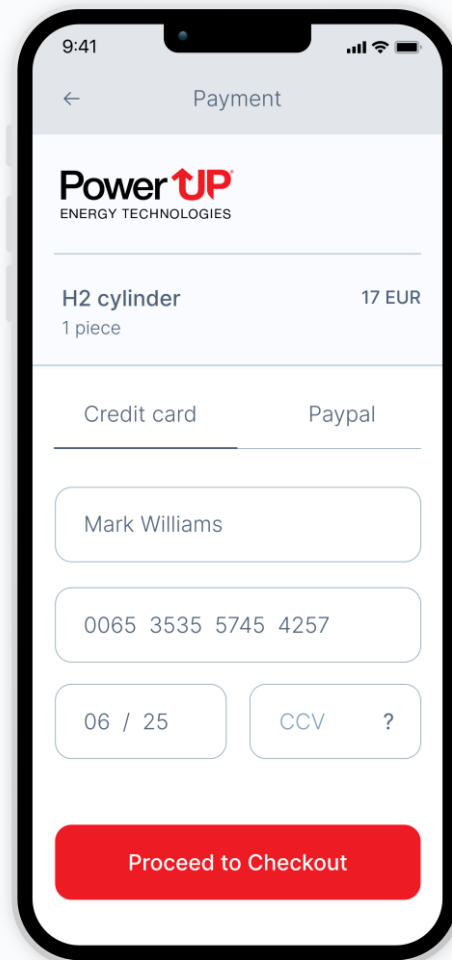

Hydrogen

We have established **unique hydrogen network** together with our partners:



Intellectual property

Main patents & filing process

- ✓ Portable Fuel Cell BackUP system
- ✓ Closed Cathode Fuel cell Stack
- ✓ Isolated DC/DC Converter
- ✓ Bipolar Plate
- ✓ Printed Circuit board
- ✓ Membrane Electrode Assembly



Lifecycle assessment

Green H2 **UP400**
36.8 kg-CO₂ / 400 W



Diesel Generator
131.5 kg-CO₂ / 400 W

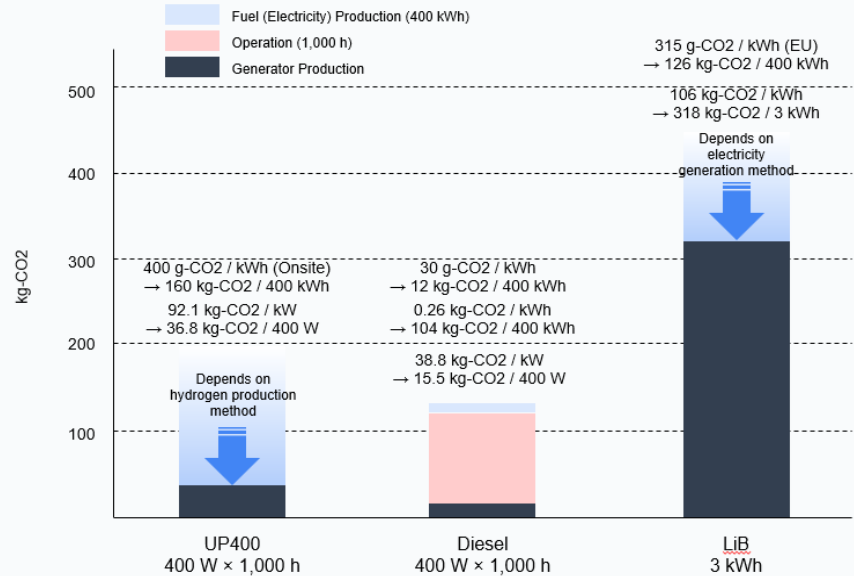
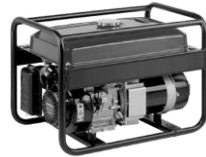

2030 Cumulative Carbon Impact = 100mt CO₂

Competition

PowerUP is an emerging leader in the low and medium power fuel cells market

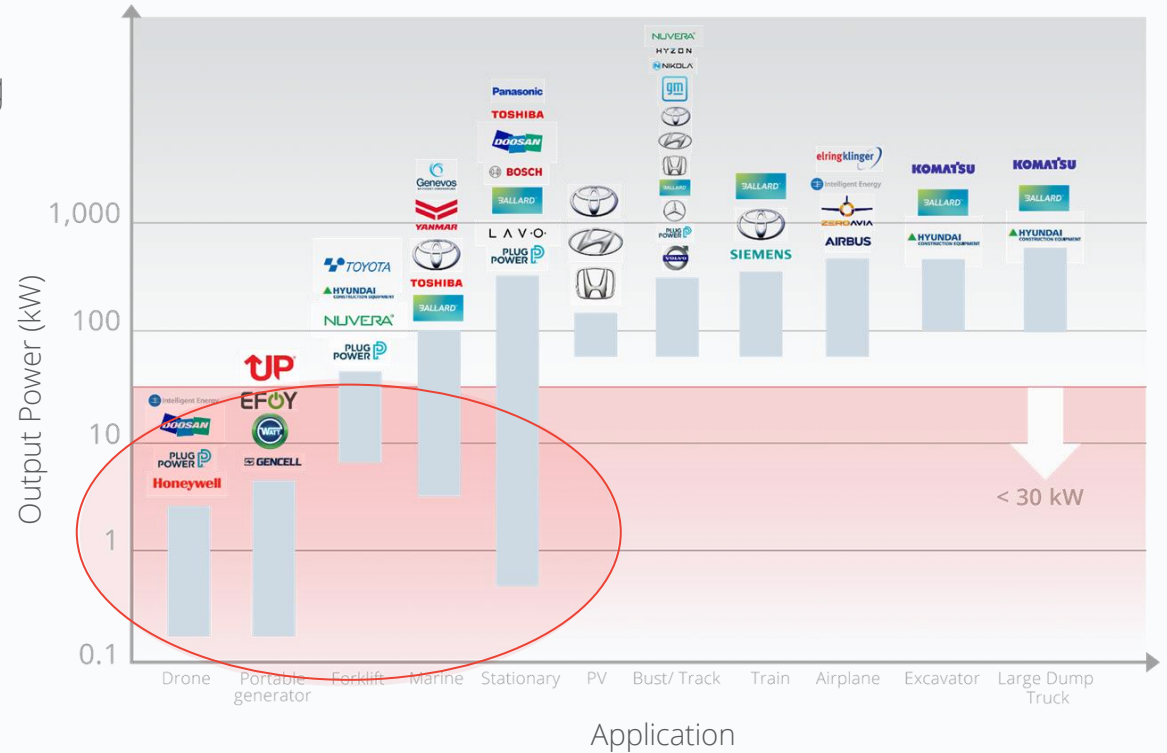

Our team is our biggest asset

- We are a team of **30 members** from 7 different nations
- Combined experience of over **60 years** in fuel cell R&D and production
- Combined experience of over **35 years** in sales & marketing
- Team members have serviced companies such as Nissan, Schaeffler, Pernod Ricard, Nestle, Carlsberg, Facebook and Adobe to name a few



Our advisors



MATI OTSMAA



DIGBY MACDONALD



ALBERT CHU



Our partners



Financials

Business Plan 2027 - in mEUR

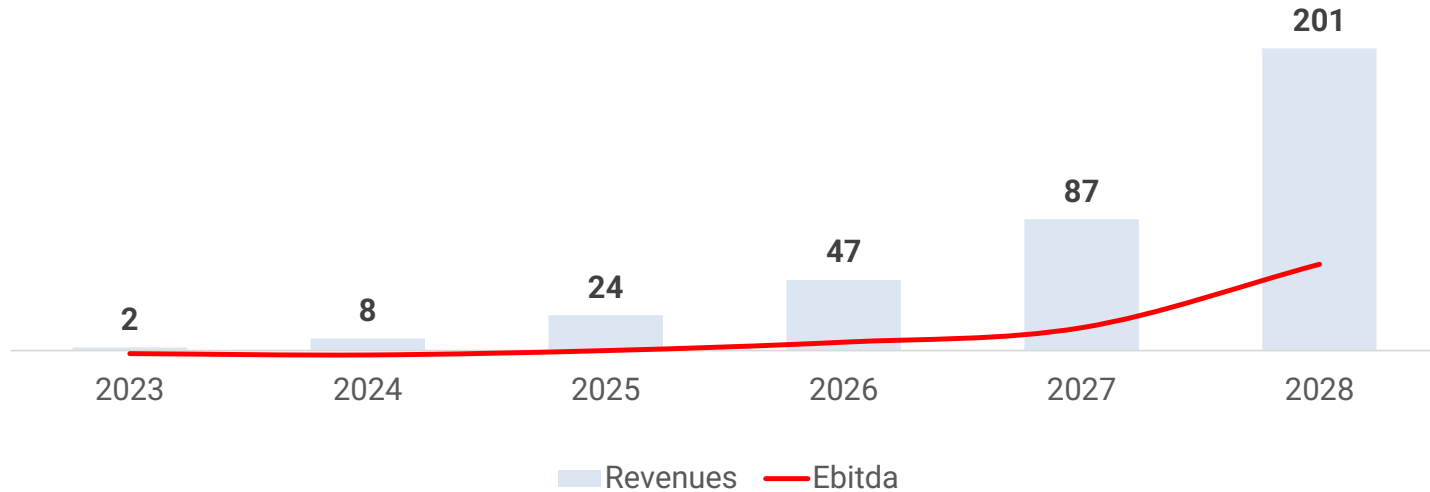

Fundraising

We are looking for an investment of **15m€** to...



...conduct marketing campaigns



...boost sales



...manage IP



...certify the products



...develop production unit



Power **UP**[®]
ENERGY TECHNOLOGIES

www.powerup-tech.com

ivar@powerup-tech.com

CONFIDENTIAL

